

AM · PM

LIKE



W80C-019-090MTA64

ENG · RUS



Installation instructions

- Installation of item should be carried out only by qualified personnel, following the instructions of this guidance.
- Assembly is carried out by two persons.
- Please, check for presence of all details after unpacking. Glass panels must be transported vertically.
- Please, lean glass panels vertically against the wall during assembly of other parts.
- It is expressly prohibited to tap upon corners of glass panels.



Product maintenance

- For the avoidance of damage of the surface of the product it is not allowed to use water of temperature more than 60 °C.

- Use only mild detergents and soap for cleaning of the item.
- Do not use corrosive washing agents or abrasive pastes for cleaning of the item.
- Accute contamination on the surface is recommended to treat with diluted vinegar and wash off with water.
- Shallow scratches (for acrylic parts of the item) can be removed with fine grid sandpaper (grade 2000).

Producer has a right to introduce change of component parts that has no effect on appearance and functionality of product. All parameters indicated in this instruction have formal meaning. Producer reserves the right for technical changes.

After assembly sealant must be given some time to harden. It is forbidden to use item within 24 hours after completion of installation.



Указания по монтажу

- Установка изделия должна производиться только квалифицированным персоналом, следуя инструкциям данного руководства.
- Сборка осуществляется силами двух человек.
- После распаковки проверьте наличие всех деталей. Стеклопакетные панели должны транспортироваться вертикально.
- После распаковки стеклопакетные панели прислоняйте вертикально к стене на время сборки остальных частей.
- Категорически запрещается стучать по углам стеклянных панелей.



Уход за продуктом

- Во избежание повреждения поверхности изделия не допускается использование воды температурой более 60 С.
- Используйте для очистки изделия мягкие моющие средства или мыло.
- Не используйте для очистки изделия агрессивные моющие средства или абразивные пасты.

- Сильные загрязнения на поверхности рекомендуется обработать разбавленным уксусом и затем смыть водой.
- Неглубокие царапины (для акриловых составляющих изделия) могут быть удалены мелкозернистой наждачной бумагой (зернистость 2000).

Производитель имеет право на изменение комплектации, не влияющее на внешний вид и функционал продукта. Все параметры, указанные в данной инструкции, имеют формальное значение. Производитель оставляет за собой право на технические изменения.

Места примыкания изделия к стенам обработайте силиконовым герметиком (показан к применению любой силиконовый герметик отвечающий свойствам pH-нейтральности, бесцветности, противогрибкости).

После сборки требуется дать время затвердевания герметика. Не рекомендуется использование изделия в течении 24 часов после завершения монтажных работ.

AM·PM

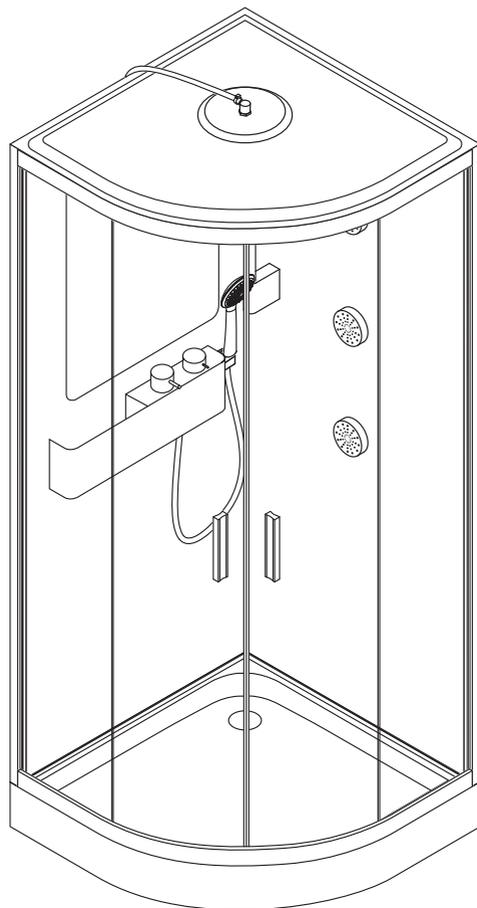

Like
W80C-019-090MTA64

ENG Shower cabin

RUS Душевая кабина

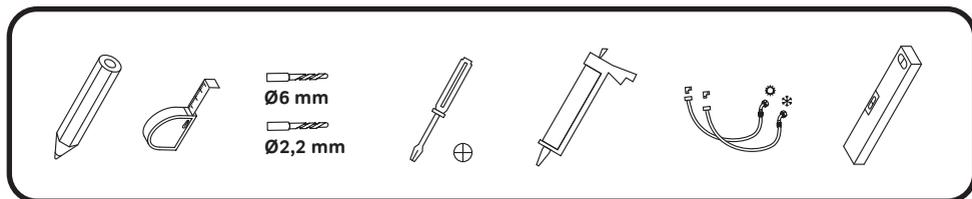
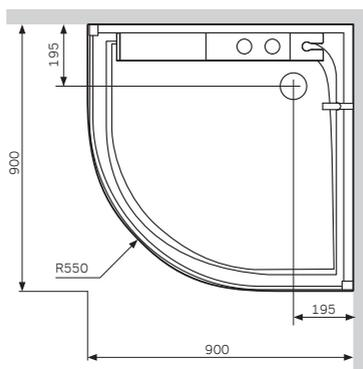
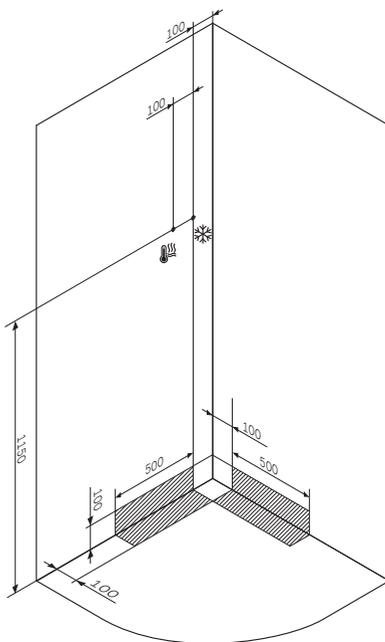
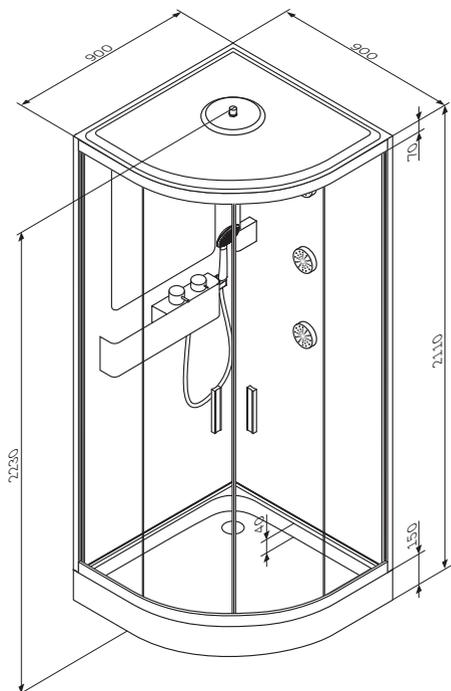

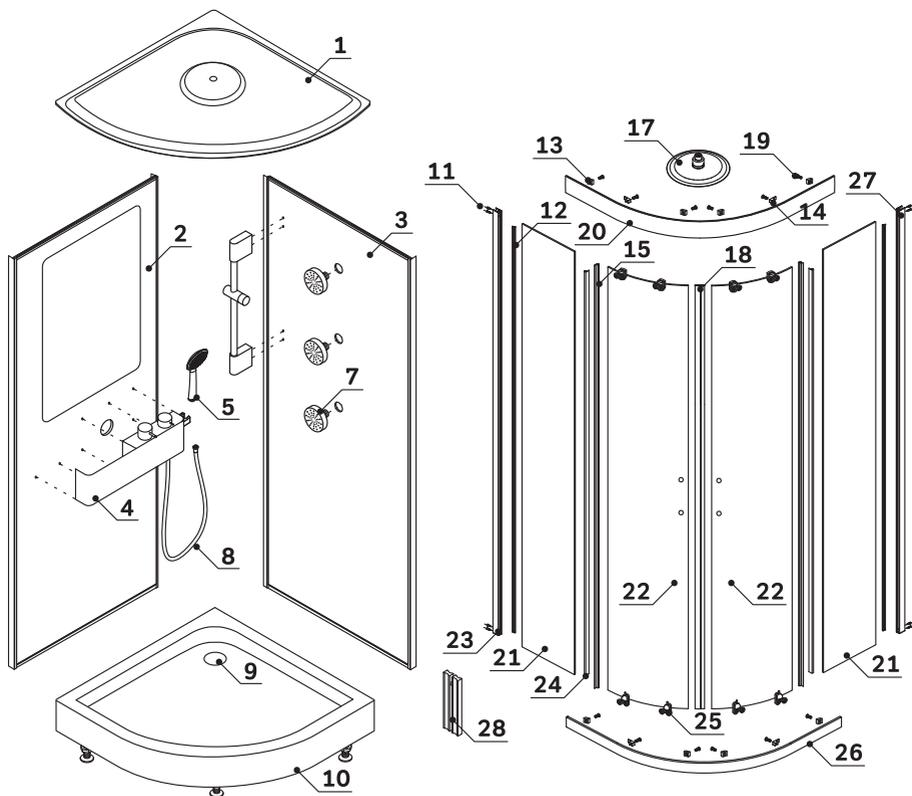

01	Roof	Купол	×1
02	Rear glass (with mirror)	Стекло заднее (с зеркалом)	×1
03	Rear glass (with injectors)	Стекло заднее (с форсунками)	×1
04	Shelf (with fastening kit)	Полка (с комплектом крепежа)	×1
05	Hand shower	Лейка ручная	×1
06	Stand shower	Стойка душевая	×1
07	Nozzle massage	Форсунка массажная	×3
08	Hose shower	Шланг душевой	×1
09	Siphon with gofrey	Сифон с гофрой	×1

10	The pallet is low	Поддон низкий	×1
11	Screw 3,9x32	Саморез 3,9x32	×8
12	The gasket E-glass	Уплотнитель стекла E-обр.	×4
13	Stopper	Стопор роликов	×8
14	Glass retainer	Фиксатор стекла	×4
15	Seal scalloping door 1900mm	Уплотнитель гребешковый двери 1900мм	×2
16	Roller upper	Ролик верхний	×4
17	Overhead shower	Лейка верхняя	×1
18	The gasket of the magnetic (kit)	Уплотнитель магнитный тип 2 (комплект)	×1

6 *гибкая подводка для подключения к выходам водоснабжения в комплект поставки не входит и докупается клиентом отдельно, в зависимости от необходимой длины подводки.

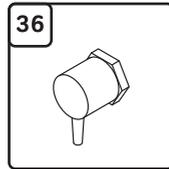
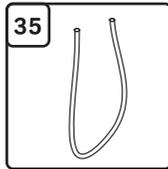
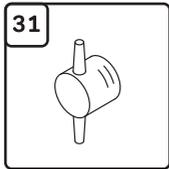
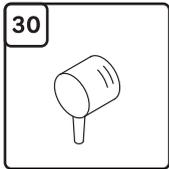
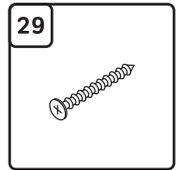
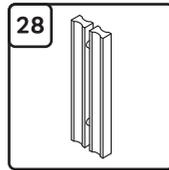
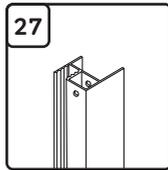
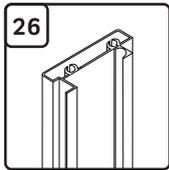
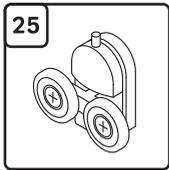
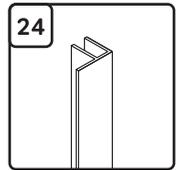
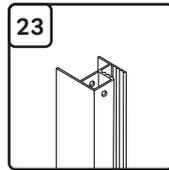
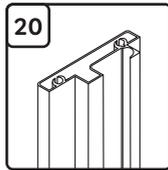
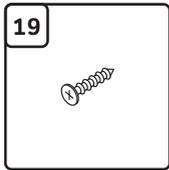
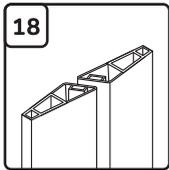
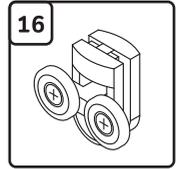
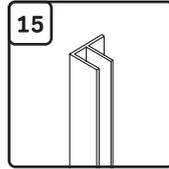
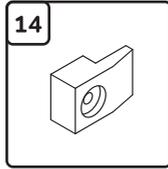
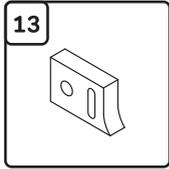
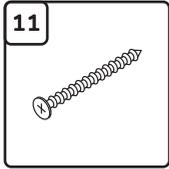
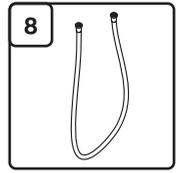
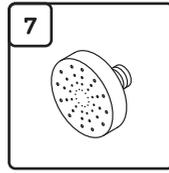
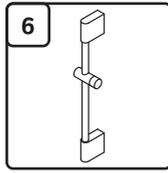
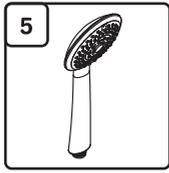
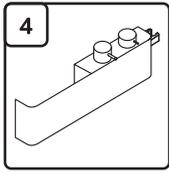

19	Screw 3,9x9,5	Саморез 3,9x9,5	×30
20	Hor. profile (top)	Профиль гор. (верх.)	×1
21	Glass flat 5x1855x314mm	Стекло плоское 5x1855x314мм	×2
22	Glass bent 5x1900x384mm	Стекло гнутое 5x1900x384мм	×2
23	Vert. profiles (left)	Профиль верт.(лев.)	×1
24	Seal scalloping 1855mm	Уплотнитель гребешковый стекла 1855мм	×2
25	Lower roller	Ролик нижний	×4
26	Hor. profile (bottom)	Профиль гор.(нижн.)	×1
27	Vert. profile (right)	Профиль верт. (прав.)	×1

28	Door handle (kit)	Ручка дверная (комплект)	×1
29	Screw 3,9×19	Саморез 3,9x19	×14
30	Connector injector single	Коннектор форсунки одинарный	×1
31	Connector dual atomizer	Коннектор форсунки двойной	×2
32	Hose PVC 300mm	Шланг ПВХ 300мм	×2
33	Clamp	Хомут	×7
34	PVC hose 1200 mm	Шланг ПВХ 1200мм	×1
35	PVC hose 1700mm	Шланг ПВХ 1700мм	×1
36	Connector G-piece 1/2"	Коннектор Г-обр. 1/2"	×2

*flexible eyeliner for connection to the water supply outlets is not included in the delivery set and is bought by the customer separately, depending on the required length of the eyeliner

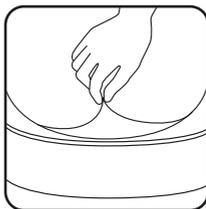
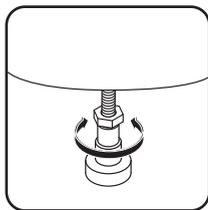
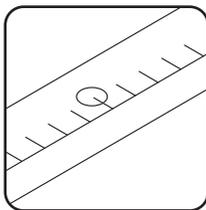
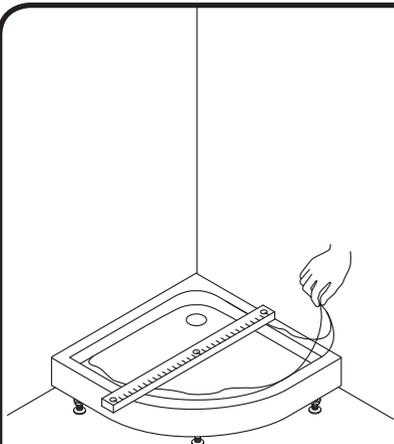

9 10

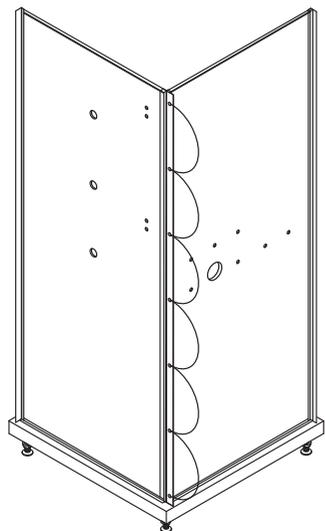

2 3

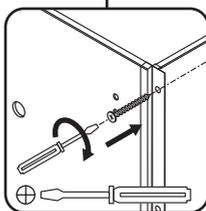
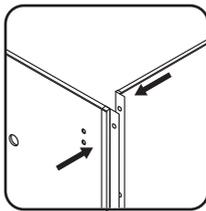

2 3 19

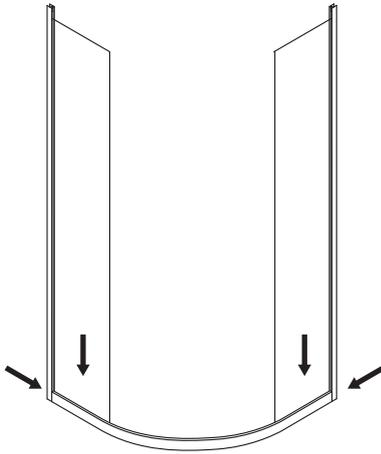

11

23

26

27

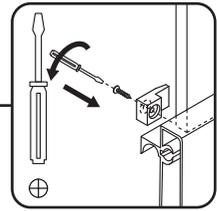
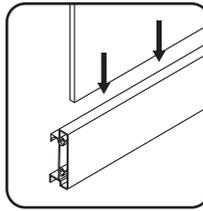
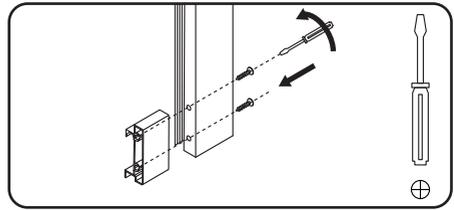

14

19

21

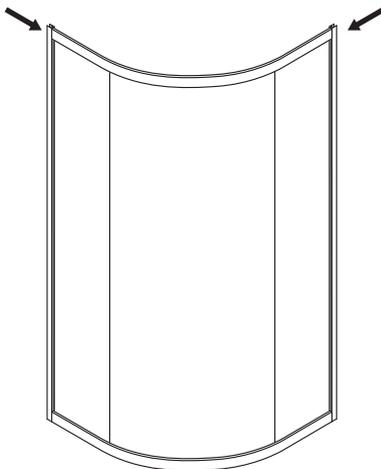

11

20

23

27

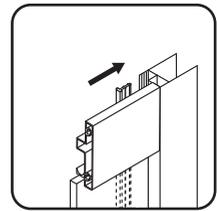
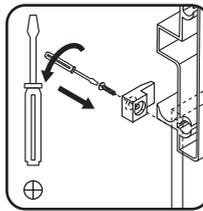
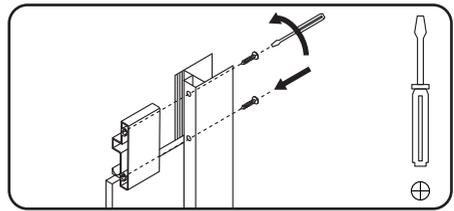

14

19

21

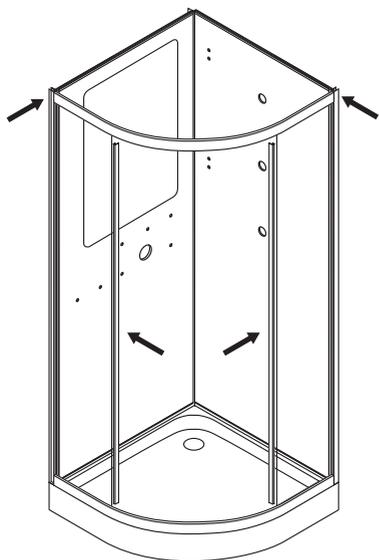

19

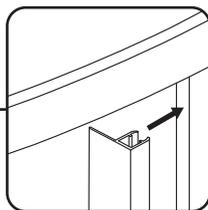
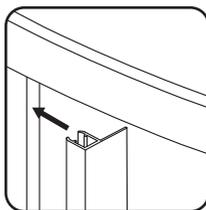
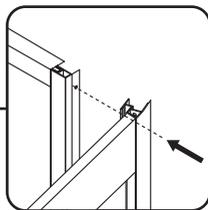
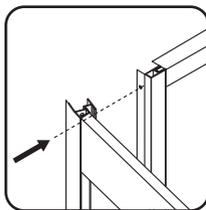

16

22

25

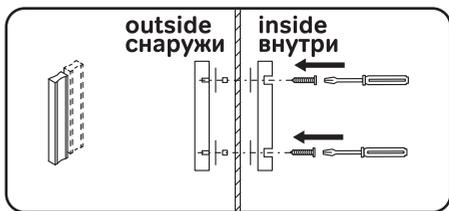
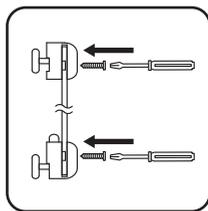
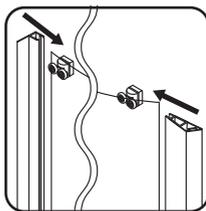
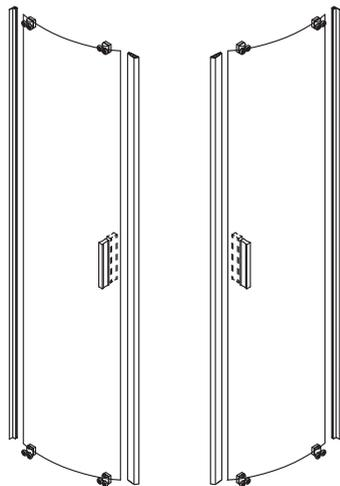

15

18

28

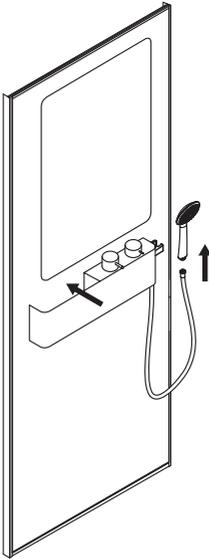

4

5

8

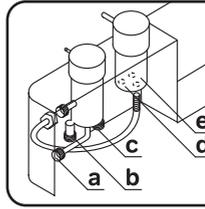
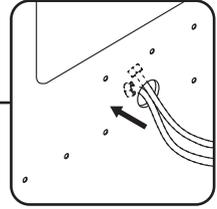
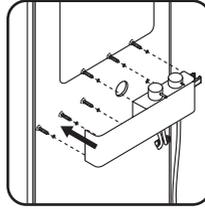

a - форсунки
 b - ручн. душ
 c - верх. душ
 d - хол. вода
 e - гор. вода

a - jets
 b - hand shower
 c - head shower

d - cold water
 e - hot water

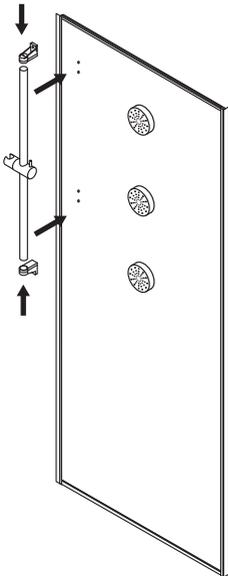

6

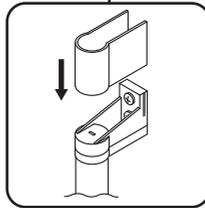
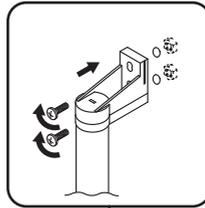

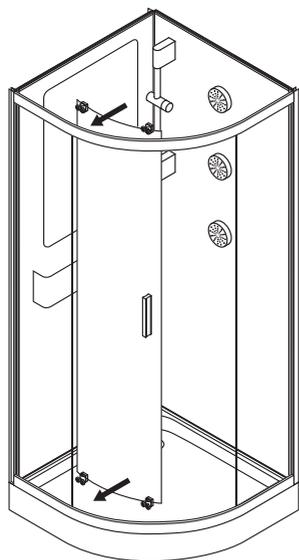

16

22

25

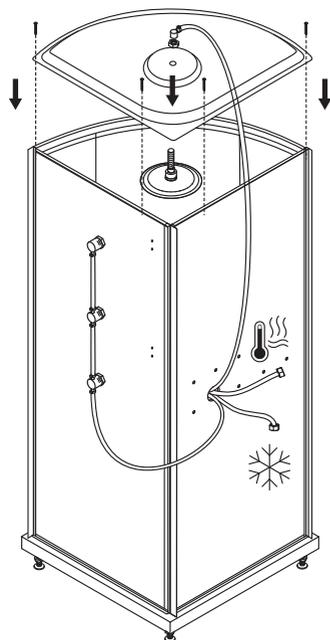
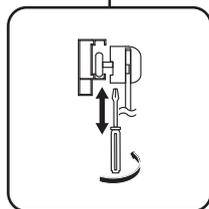
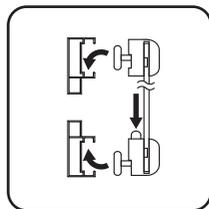
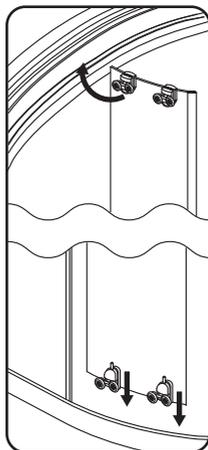

17

19

33

35

36

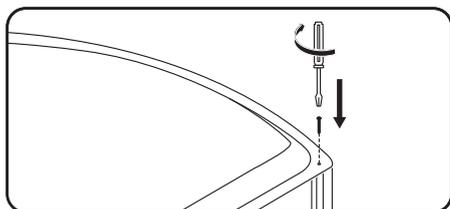
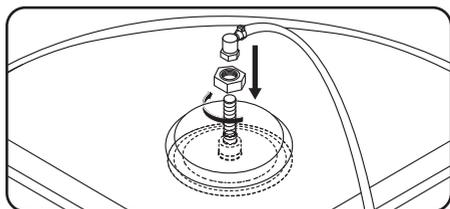

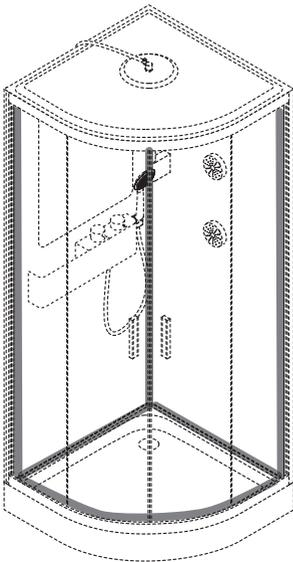
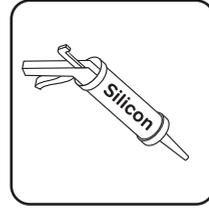
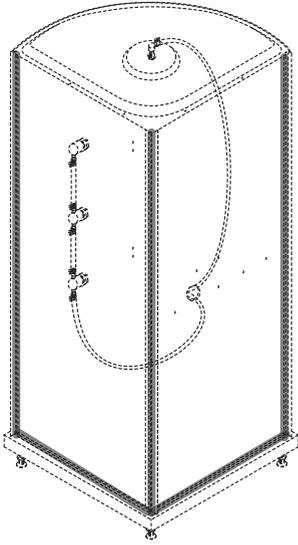

AM·PM

AM.PM Europe GmbH
Torstrasse 177 D-10115 Berlin
www.ampm-world.com 02/2018